

## HORIZONTAL CABLE MANAGER FINGER STYLE

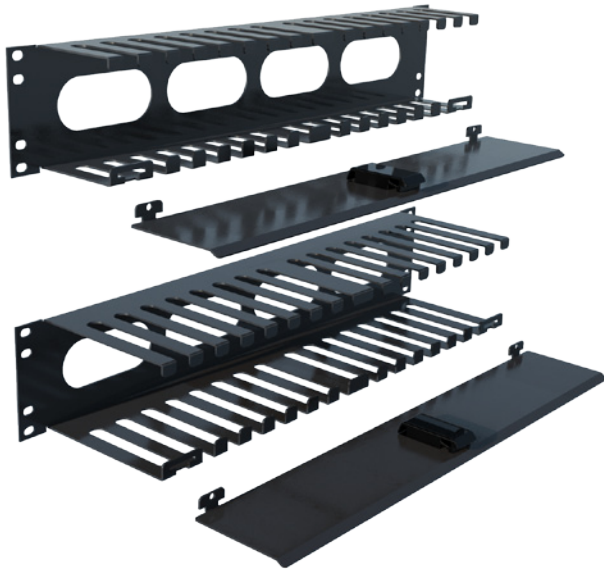

Features:

- Heavy gauge steel
- Removeable door for ease of cable installation and removal
- Door latches closed
- Durable black textured powder coated finish

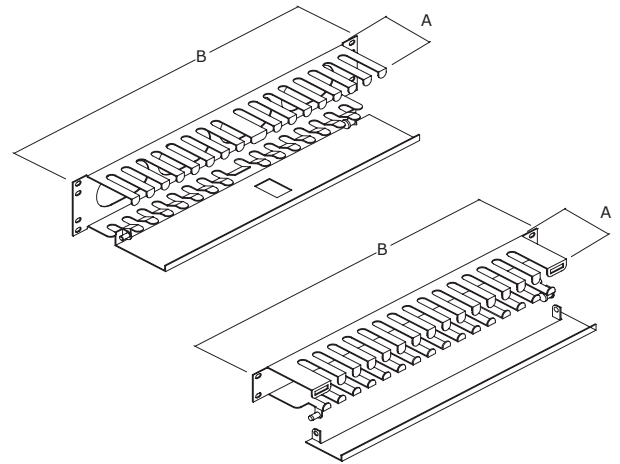

Part number	A	B	# of U's
RFM-191D-HCM-F	3.00	19.00	1U
RFM-192D-HCM-F	3.00	19.00	2U
RFM-191D-HCM-FD	5.00	19.00	1U
RFM-192D-HCM-FD	5.00	19.00	2U
RFM-194D-HCM-FD	5.00	19.00	4U

## HORIZONTAL CABLE MANAGER FINGER STYLE: HIGH DENSITY ADJUSTABLE



Features:

- Heavy gauge steel
- Removeable door for ease of cable installation and removal
- Adjustable mounting brackets allow the unit to be installed with an offset of 3", 5.5", or 7.5" in front of the rack
- Door latches closed
- Designed for use with patch cords with extra long boots
- Durable black textured powder coated finish

Part number	A	B	# of U's
RFM-192D-HCM-FHD	8.125	19"EIA	2U

